



Model 80 a 100



Model 120



Model 80 a 100

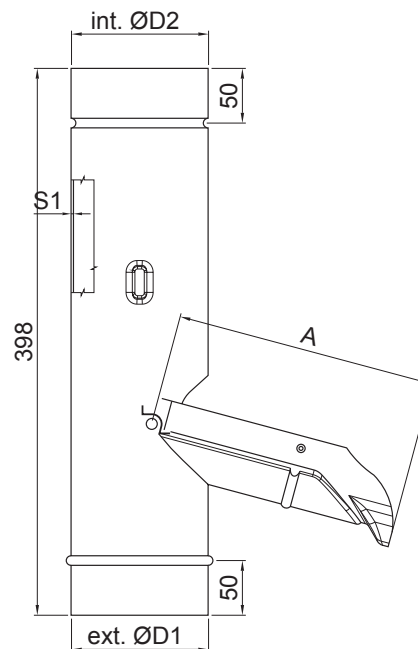



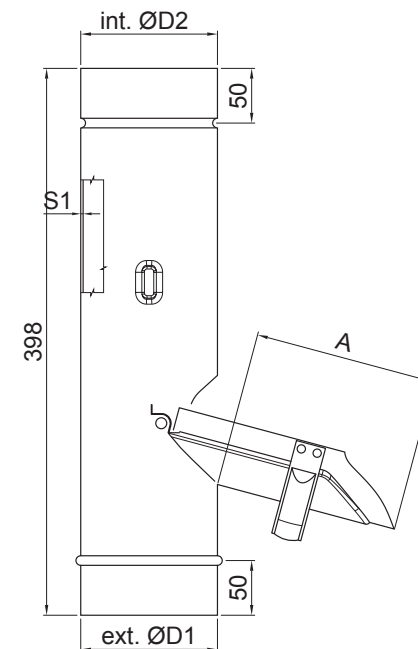





Model 120







| Menovité rozmery (mm) | 80 | 100 | 120 |
|-----------------------|------|------|------|
| S1 | 0,55 | 0,55 | 0,55 |
| A | 150 | 190 | 230 |
| ØD1 | 80 | 100 | 120 |
| ØD2 | 80 | 100 | 120 |

Pre presné spojenie a kompatibilitu s existujúcimi žľabmi, zvodovými rúrami a príslušenstvom, je potrebné, aby boli dodržané rozmery podľa údajov STN EN 612.

Artikel – Objednávkové číslo ZV ✱ PRÉMIUM 80, 100

| Menovitý rozmer (mm) | 80 | 100 | 120 |
|---|--|--|---|
| ● Pozink DX51D+Z, Z225, EN 10346/15 | ● | ● | ● |
|  Objednávkové číslo | 8584074034380 | 8584074034397 | 8584074034403 |
|  Balenie kartón |  / 8 ks |  / 5 ks |  / 3 ks |
|  Balenie paleta |  / 240 ks |  / 150 ks |  / 90 ks |

KJG DESIGN – Pozinkované zachytávače vody

| | |
|--|---|
|  3D – náhľad |  Produktový prospekt web |
|  Technický list o produkte |  Objednávkové číslo |
|  Montážny list |  Balenie |